

# HEWLETT-PACKARD JOURNAL

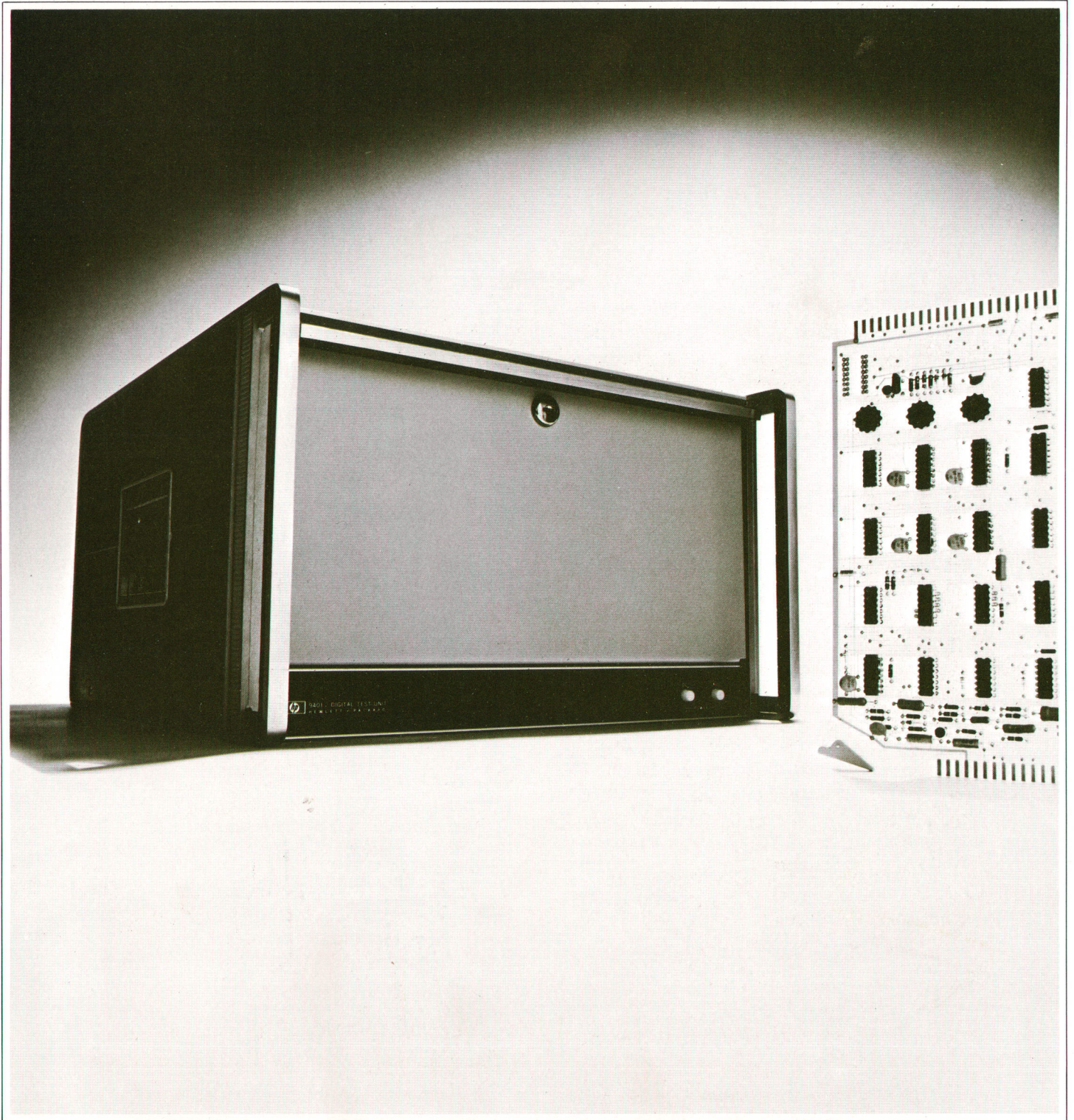

JULY 1971

# General-Purpose Test System Gets Digital Capability

*HP's most general-purpose computerized automatic test system can now test digital and analog/digital electronic devices as well as purely analog devices. A new subsystem gives it a functional logic test capability.*

**By Leif Gudnitz and Homer Tsuda**

HEWLETT-PACKARD 9500 SERIES AUTOMATIC TEST SYSTEMS are computerized systems for testing electronic devices. A 9500 system is a stimulus/response test system: it has power supplies and signal generators to provide input stimuli to the device under test, and it has measuring instruments to monitor the outputs produced by the device in response to the inputs. Everything is controlled by the computer, which is programmed in a version of the BASIC language called ATS BASIC\*—it's an interactive, easy-to-learn language that includes statements for controlling instruments.

9500 systems are put together using mostly off-the-shelf hardware. They're modular in design, so they can be custom-tailored to fit a wide variety of electronic test applications. Modularity makes them easy to modify and expand, too.

Now these flexible, modular systems can test a wider variety of devices than ever before. A new digital test subsystem, Model 28035A, can be installed in any 9500 system just like any other instrument or module (see Fig. 1). It's designed to do functional logic testing (see box, page 4) and it gives the system the ability to control and test either purely digital devices or devices with combinations of analog and digital inputs and outputs. Previously, 9500 systems could only test analog devices. The digital test subsystem is itself modular and expandable, and it's designed to be reliable and easy to service. Self-test is done by diagnostic computer programs.

## Digital Subsystem Capabilities

The new digital subsystem is suitable for testing integrated circuits, printed circuit cards, logic modules, and

\* ATS (for Automatic Test System) BASIC is an expanded version of HP BASIC, specifically designed for instrument control in an automatic test system. One of its major features is a mnemonic statement form for instrument control, e.g., DCV ( ) calls a dc voltage source control routine, DVM ( ) calls a digital voltmeter control routine, etc.

many other devices. Units to be tested may have as many as 240 pins (inputs and outputs). The subsystem's capacity can be expanded from 12 pins to 240 pins in 12-pin increments. Any pin can be designated as either an input or an output; this is done in the computer program and no hardware changes are necessary.

The digital subsystem supplies input pins with logic 'high' and logic 'low' levels between +12 V and -12 V, and supplies or sinks up to 30 mA of current at each pin. Logic high and low levels are preset independently and are the same for all pins. Output pins are tested by

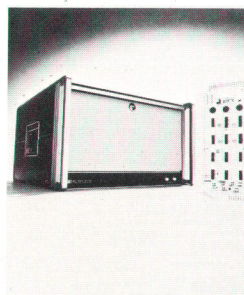

**Cover:** 'Digital testing with HP 9500-Series Automatic Test Systems' is the idea we're trying to get across here. The instrument is the 9401B Digital Test Unit, heart of a new digital test subsystem that multiplies the capabilities of these modular computer-controlled systems.

## In this Issue:

*General-Purpose Test System Gets Digital Capability*, by Leif Gudnitz and Homer Tsuda ..... **page 2**

*Digital Testing versus Digital Testing* ... **page 4**

*Optical Power Measurements Made Easy*, by Charles L. Hicks and Michael R. Mellon ..... **page 10**

*Multitudinous Applications* ..... **page 14**

*Units of Optical Power* ..... **page 15**

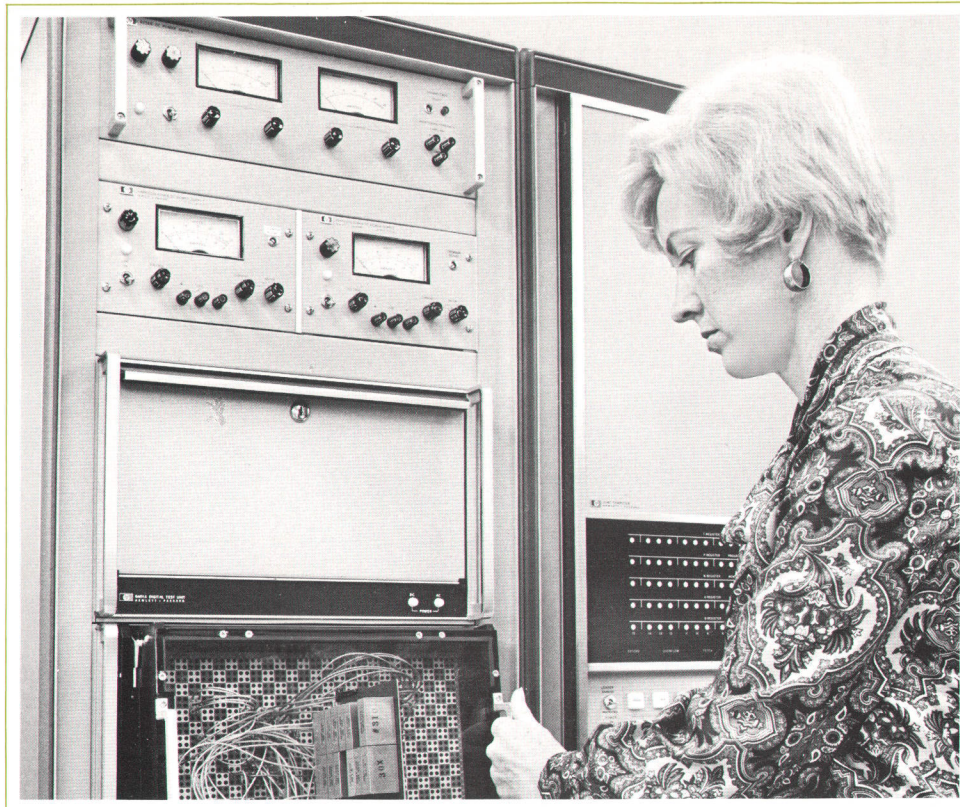

**Fig. 1.** This is the new Model 28035A Digital Test Subsystem for HP 9500-series systems. For simplicity no analog instruments are shown, but systems can have any combination of analog and digital test capability.

comparing the voltages at such pins with preset threshold levels. There are two thresholds, each of which can be set independently anywhere between +12 V and -12 V. One threshold is used for 'greater than' decisions and the other for 'less than' decisions.

Test rates are determined by the propagation delay of the device under test and the number of pins it's necessary to update per test. The maximum test rate is approximately 22,000 tests per second, assuming up to five microseconds propagation delay in the device and only 12 pins to be updated per test. If 120 pins need to be updated for every test, then the test rate will drop to 4000 tests per second. In practice the number of pins to be updated will typically vary from test to test and the average test rate will be somewhere between these figures.

The subsystem doesn't need a standard or known good unit to use as a reference. All test patterns—inputs and outputs—are stored in the computer's memory or in a bulk memory device such as a disc. However, the software is designed so it's possible to minimize programming time by specifying only input patterns, using a standard unit to obtain the output patterns.

A programmable delay, ranging from one to 4095 microseconds in 1  $\mu$ s steps, can be inserted between the application of stimuli to the unit under test and the

time the unit's response is sampled, thereby allowing the unit time to settle.

#### **Digital Test Subsystem Hardware**

In its basic form the 28035A Digital Test Subsystem consists of four instruments: a digital test unit and three power supplies.

The heart of the subsystem is the 9401B Digital Test Unit (DTU) which consists of an instrument case with a card cage. In opposite ends of the card cage are a timing and control card which interfaces to the computer card with a cable, and a load card which terminates the backplane of the card cage and contains test points for all analog voltages within the DTU. All power to the DTU is supplied by the three power supplies. The card cage has room for up to 10 test modules, each of which has a 12-pin test capability. Thus a full DTU has a 120-pin test capability. A 240-pin capability requires two digital test units, and the second DTU requires a separate set of power supplies.

#### **Software Features**

For programming the new digital subsystem a modular software package has been added to ATS BASIC, the interactive language used by all 9500-series systems. It's designed to make it easy to translate written test

## Digital Testing versus Digital Testing

There's more than one kind of digital testing. The two basic kinds are functional testing and parameter testing.

Functional testing can be divided into static functional testing and clocked functional testing. Static functional testing, sometimes called truth-table testing, is used to verify the logic of the unit under test. Patterns of logical 1's and 0's of appropriate voltage levels are supplied to the input pins of the unit under test and its output patterns are compared with the expected patterns. Two comparisons are needed, one to check that the unit responds with the appropriate voltage levels, and the second to check that the pattern of 1's and 0's is correct. The number of tests needed to check a device completely may become very large as the complexity of the device increases, and exhaustive functional testing may not be possible for some sequential logic circuits. Sequential logic may also require a number of input patterns to bring it to a known initial state before testing can begin.

Clocked functional testing is the kind of testing that must be performed on dynamic MOS registers. These devices must be clocked at short intervals or they'll lose their information. Thus the functional test must be carried out at the operational speed of the device.

Parameter testing is divided into dc or static testing and ac or dynamic testing. During dc testing the voltages and

currents of the inputs and outputs pins of the unit under test are measured. For an input pin this is done by first bringing the device to a known state and then, without changing the state, applying a known voltage to the input pin and measuring the current. For an output pin, the current is forced and the voltage measured. These tests insure that the device has proper fan-in and fan-out capability. The number of dc tests needed to check a device completely is primarily a function of the number of input and output pins.

Ac tests are those in which time-dependent parameters such as delays, rise and fall times, and pulse widths are measured. This type of test requires a highly controlled test environment to make certain that the waveforms aren't disturbed and the time intervals are measured accurately.

An absolutely complete test would include all of the various kinds of digital testing, but this is seldom done because the cost goes up as more kinds of tests are added. For cost-effectiveness reasons, functional testing is used as the primary method of sorting digital devices and modules. It's capable of detecting most common failures, such as printed-circuit-board cracks, bad lead bonds, and transistor opens or shorts. It's a basic requirement for digital devices of even low complexity and becomes increasingly important as the complexity increases. Static functional tests are the kind made by the new HP 28035A Digital Test Subsystem.

procedures to test programs, whether the procedures are given as step-by-step instructions, as logic timing charts, or as truth tables showing only sequences of input and output logic states. Features of the software package are an interactive mode for generation of test programs, flexible test sequence control allowing for fault isolation and diagnostics, direct execution of tests from stored patterns for higher test rates, and pattern segmentation for long test sequences.

The modules in the software package are called digital test unit drivers. The user calls on these drivers by means of appropriate statements in his ATS BASIC program. The table on page 7 lists the drivers and their corresponding statements.

### How It Works

Fig. 2 is a block diagram of the digital test unit. The computer and the timing and control card in the DTU communicate by means of 16-bit parallel words in a 'handshake' mode of operation. Program and test information is transmitted from the computer and DTU status is available to the computer.

The best way to explain the operation is by an example. We'll use the simple quad NAND gate of Fig. 3 as our unit under test.

First the user must decide which pins of the unit under test shall correspond to which DTU pins. Once the unit's pins are renumbered to correspond with the test fixture, the user can begin to write his program. In our example we've chosen to use the first 12 DTU pins.

### Writing the Program

Next the supply voltage, input levels, and comparator thresholds must be set. If the test system includes digital voltage sources such as the HP 6130B, the ATS BASIC statements will be:\*

```
10 DCV (1, 5, 100)
20 DCV (2, 4, 20)
30 DCV (3, .2, 20)
40 DCV (4, 2, 20)
50 DCV (5, .8, 20)
```

Here statement 10 sets the supply voltage and current limit for the unit under test, statements 20 and 30 set high and low logic levels, and statements 40 and 50 set the two comparator thresholds in the DTU.

Once the reference voltages have been set, the first instructions to the DTU must be statements pertaining

\* If the system contains only manual power supplies the program would instead be written to print a message to the operator, telling him where to set voltages and current limits. The PRINT statement(s) would be followed by a PAUSE statement which would cause the system to wait for the operator action.

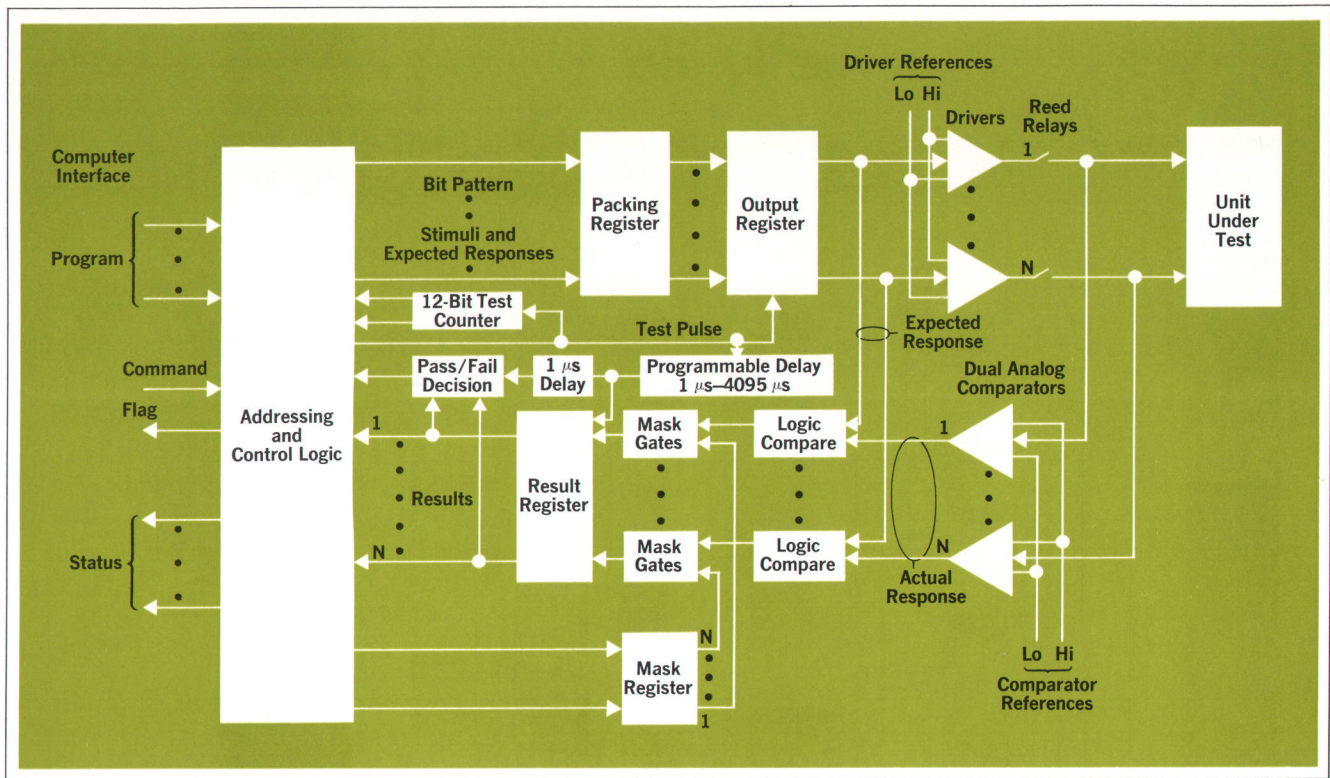

**Fig. 2.** The digital test unit contains driver and comparator circuits for every pin. Input and output pins are specified in the BASIC program and no hardware changes need be made.

to which pins shall be inputs and which pins outputs of the unit under test. The initial program statement is a 'Define' statement, DTUDEF(M), where M is a parameter specifying whether you are making a new definition of pins or modifying an existing one. This statement must be followed immediately by two REM statements, one listing the DTU pins that are connected to inputs of the unit under test, and the other listing the DTU pins that are connected to outputs of the unit under test. Thus the program might continue as follows:

```

60 DTUDEF (1)
70 REM INPUTS 1, 2, 4, 5, 8, 9, 11, 12
80 REM OUTPUTS 3, 6, 7, 10
90 DTUSD (5)
100 PRINT "INSERT DEVICE"
110 PAUSE

```

Statement 60 indicates a new definition of pins. It causes the DTU to be cleared such that it's in a known initial state. Statement 70 connects the pins named in it to driver circuits in the DTU by closing reed relays. Statement 80 unmask the named output pins by opening gates; this allows a failure at one of these pins to be recorded in the result register in the DTU. Pins named

as inputs and pins left undefined remain masked and automatically pass all tests.

Statement 90, DTUSD(5) programs a five microsecond delay between the time the inputs are applied and the time the outputs are tested.

Statement 100 calls for action on the part of the operator and statement 110 stops the program to wait for the operator to act. After he inserts the test device the operator restarts the program.

#### Specifying the Test Pattern

The next step in writing the program is to specify the test pattern. Two methods can be used. The first is to select either high or low polarity and then give the list of pin numbers to have that polarity. The sequence of statements is

```

DTUTP(P, Y, S, E)
REM <pin list> T

```

where P specifies the polarity. This method of specifying a test makes for rapid translation of test procedures given as logic timing charts.

When several tests are to be made, several REM statements are used. Each REM statement specifies the

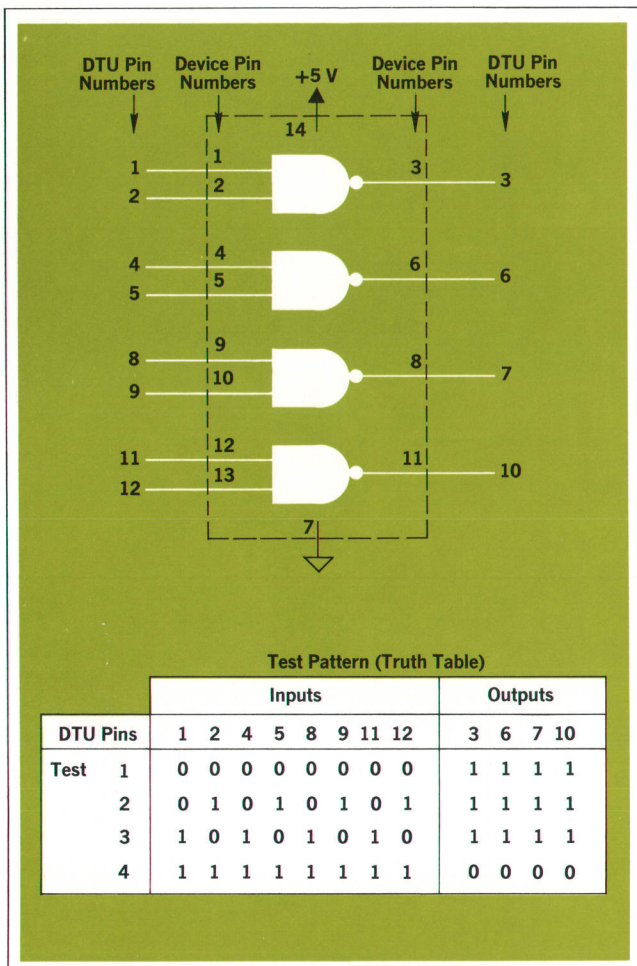

Fig. 3. A simple quad NAND gate to be tested. Test program is explained in text. Digital devices to be tested can have as many as 240 pins.

input pins to be set to the selected polarity and the output pins expected to have that polarity. With this method each test is explicitly stated and is independent of the other tests, so addition or deletion of tests is a simple matter.

REM statements that specify tests must be terminated with the letter T. The remainder of each line following the letter T is ignored by the system and can be used for comments.

The parameters Y and S are entry and exit controls used for specifying such things as branch on fail, branch after test, continue to next test, or repeat test. These parameters allow considerable flexibility in defining the sequence of tests, and are useful in failure analysis and fault isolation. When a branch is called for, control is transferred to statement number E in the BASIC program.

An alternative method of specifying test patterns is

to select high or low polarity, give a pin list, and then give a series of zeros and ones indicating whether each pin is to have the selected polarity (1) or the opposite polarity (0). The sequence of statements is

```
DTUTP(P, Y, S, E)
REM P <pin list>
REM <series of zeros and ones> T.
```

There is a separate REM<0/1>T statement for each test. This method is useful when the test procedure is given as a truth table.

To eliminate repetitive specification of input pin levels that don't change, there's also a DTUFX statement that fixes specified pins at either logic level until redefined.

For our quad NAND gate example, we'll choose the second method and use the truth table shown in Fig. 3 even though test #1 is superfluous. The program continues as follows.

```
120 LET Y = 1
130 DTUTP (2, Y, 1, 5000)
140 REM PINS 1-6, 8, 9, 7, 11, 12, 10
150 REM 001 001 001 001 TEST #1
160 REM 011 011 011 011 TEST #2
170 REM 101 101 101 101 TEST #3
180 REM 110 110 110 110 TEST #4
190 PRINT "END OF TEST"
200 DTURC(1, T)
210 GO TO 100
```

Statement 130, DTUTP ( ), alerts the computer that DTU tests follow. Statement 140 defines the sequence in which the pins are referenced in the following lines. Statement 150 causes the packing register in the DTU to be loaded with the programmed inputs and expected outputs. For the first test this would be

PIN #	1	2	3	4	5	6	7	8	9	10	11	12
BIT VALUE	0	0	1	0	0	1	1	0	0	1	0	0

When the packing register is loaded, the complete bit pattern is transferred to the output register on the positive transition of a test pulse, the length of which is programmable and equal to the test delay. From the output register, the test pattern is applied to the drivers and to the logic comparators. All drivers then switch high or low according to the contents of the output register, but only for pins where the reed relays are closed will the driver outputs be transferred to the unit under test. The unit will respond, and the voltage at each output pin will be compared with the preset thresholds in the analog comparators. The logical outputs of the analog comparators drive the logic comparators, which

## Software Drivers and BASIC Statements for Digital Testing

Driver Name and Type	BASIC Statement	Function
<b>Pin-Independent Drivers (interactive mode)</b>		
Read Test Counter	DTURC (R, V)	Read or reset test counter and transfer number of tests performed to BASIC variable V.
Set Test Delay	DTUSD (D)	Wait D microseconds after applying inputs for device under test to settle before checking outputs.
Set Synchronization	DTUSS (S)	Select internal or external sync source.
<b>Pin-Dependent Drivers (interactive mode)</b>		
* Define Inputs/Outputs	DTUDF (M)	Specifies DTU pins connected to inputs and outputs of unit under test.
* Fix Levels	DTUFX (P, F)	Fixes specified input pins at polarity P until redefined.
* Test with Pattern	DTUTP (P, Y, S, E)	Apply logic polarity P to specified input pins and check whether the specified output pins go to that polarity. Branch after test as specified by Y, S, E.
Read Status	DTURS (C, T, P (1), N)	Fill array P(N) with pin numbers that satisfy conditions specified by C and T.
<b>Test Pattern Array Drivers (compiled mode)</b>		
Create Test Array	DTUCA (M, A (1), N, X)	Transfers test pattern in compiled form to BASIC COMMON area.
Test with Array	DTUTA (Y, S, E, A (1), N, X)	Similar to DTUTP ( ), but uses compiled test-pattern array previously stored. Gives maximum test rate.
* Generate Pattern	DTUGP (P, C)	Used with known-good test unit for generating test patterns. Reduces programming effort.

\* These statements must be followed by one or more REM statements specifying a list of pins and/or logic states.

compare the outputs to the expected values, and the output of the logic comparators tells whether or not the expected and the actual responses matched on a bit for bit basis. This information is applied to the mask gates, which allow only pins defined as outputs to go through as possible failures. The pass/fail information is retained in the result register on the negative-going edge of the test pulse, that is, after the specified delay to allow the unit under test to settle. One microsecond later a decision will be made on the outputs of the result register by the pass/fail decision logic. If any bit of the result register indicates a failure, the pass/fail line will go to fail. This is transmitted to the computer on a status line, thereby alerting the computer that at least one pin failed.

Suppose the unit under test passes the first test. The packing register is then loaded with the next test pattern, and on the leading edge of the next test pulse the new test pattern is transferred to the output register, and on to the unit under test. Thus the unit is subjected to a non-return-to-zero word for each test pattern. When

testing is complete the operator is alerted and statement 200, DTURC ( ), resets the test counter.

If the unit is fault-free a high test rate is maintained. Failures, on the other hand, generally result in slower testing because branching is usually required. Suppose, for example, that pin 1 of the quad NAND gate is stuck high. Then it will fail test #2 because pin 3 will go low when it should go high. Whenever a test fails, control is transferred to statement 5000 of the BASIC program, where 5000 is the last parameter in statement 130.

### Reading Out Results

Suppose we want to know which test and which pin failed. The program could be as follows.

```

5000 DTUTC (2, T)
5010 DTURS (3, 2, P(1), 4)
5020 PRINT "TEST#"; T; "PINS";
5030 FOR I = 1 TO 4
5040 IF P(I) = 0 THEN 5060
5050 PRINT P(I);

```

```

5060 NEXT I
5070 PRINT "FAILED"
5080 LET Y = 2
5090 GO TO 130

```

Statement 5000, DTUTC (2,T), will cause a readout of the test counter, its value to be stored as the variable T. Statement 5010, DTURS ( ), will cause a readout of the result register, and for every failed pin, that pin number will be stored in array P(I). P(I) need only be declared four elements long since only 4 outputs can possibly fail. Pins that haven't failed will be set to zero in P(I). The teleprinter message in this case will be

```
TEST #2 PINS 3 FAILED
```

### Generating and Storing Test Arrays

Test patterns which have been verified by actual testing can be stored as test arrays simply by inserting create-array (DTUCA) statements in the BASIC program before and after the pattern to be stored (see Fig. 4). Subsequent tests using this array are then initiated with a DTUTA statement which is similar to the DTUTP statement used in the example program. For production testing only the array and the DTUTA software are required. The test-generation portion of the program isn't needed any more. This leaves most of the computer's core memory for test arrays.

For very long test sequences which exceed the computer's memory capacity, the DTU software includes parameters to control array segmentation. Long test arrays can be generated in segments and the segments stored on a magnetic disc or tape to be executed sequentially during subsequent testing.

Test arrays can also be created using a unit which is known to be good as a reference to obtain the correct output responses. This method is useful for testing complex printed circuit cards. The user specifies only the input bit patterns, using a DTUGP statement similar to the DTUTP statements in the example program. The system then performs the tests and creates a composite pattern which includes both the programmed input and the output response from the reference unit.

Using this same software feature, it's even possible to avoid specifying inputs. On command, the software will automatically generate binary or Gray code permutations for use as test inputs. Multiphase clocks can also be generated.

To reduce memory requirements and speed up testing, test arrays are compressed before they are stored, taking advantage of the non-return-to-zero characteristic of the hardware, that is, logic states are maintained

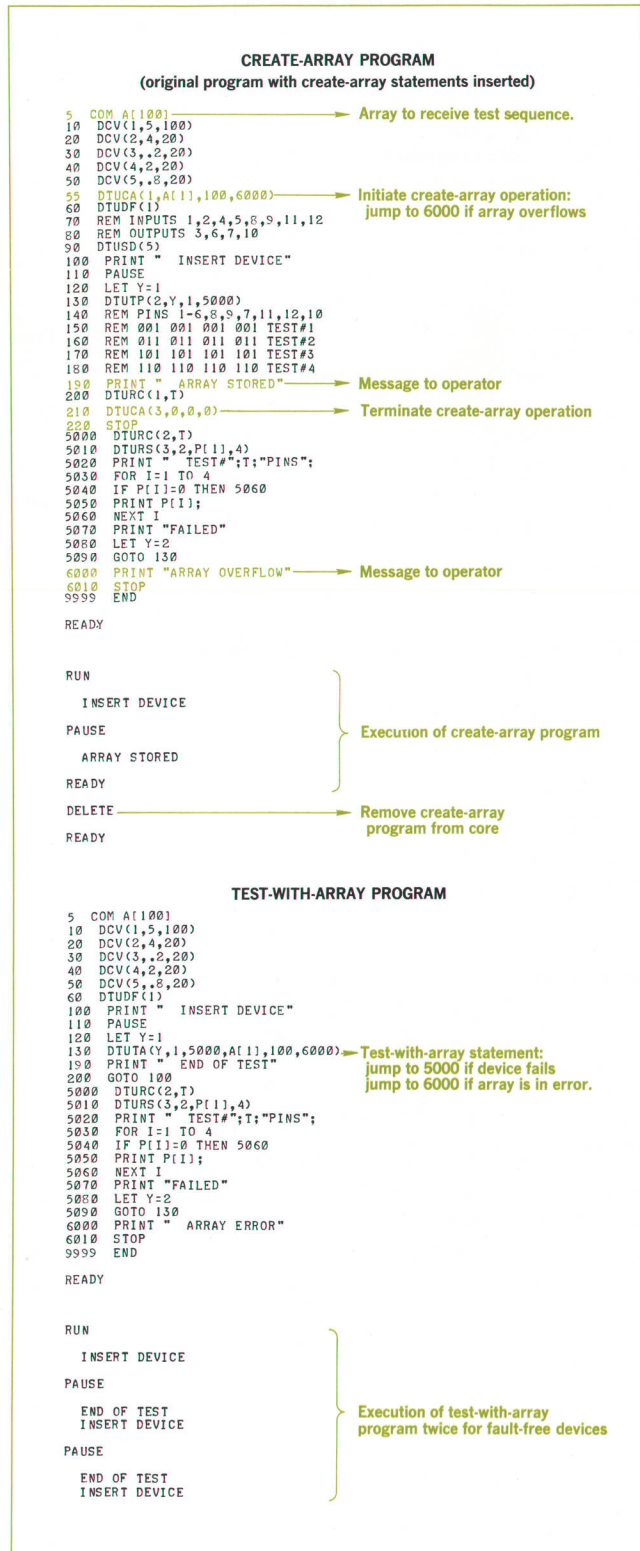

**Fig. 4.** Test pattern created and checked out in interactive mode is stored in compiled form by inserting 'create array' statements in program. Tests run much faster in compiled mode: for a 12-pin device maximum test rates are approximately 22,000 tests per second in compiled mode and 150 in interactive mode.



**SPECIFICATIONS**  
**HP 28035A**  
**Digital Test Subsystem**

**POWER REQUIREMENTS**

LINE VOLTAGE: 115 or 230 V ac  $\pm 10\%$   
 POWER: 1030 W maximum  
 FREQUENCY: 50 or 60 Hz  $\pm 5\%$

**RACK SPACE**

9401B	10.5 in.
6256B	5.25 in.
6286B (2)	5.25 in.

**OPERATING AMBIENT**

Temperature 0°C to 50°C.  
 Relative Humidity to 95% at 40°C.

**NUMBER OF PINS**

Each 9401B: 12 to 120 in 12-pin increments.  
 Maximum: 240 in two 9401B's.

**PROGRAMMABLE TEST DELAY**

1  $\mu$ s to 4095  $\mu$ s in 1  $\mu$ s increments.

**TEST SPEED:** Depends on software, number of pins, and test delay.

Maximum speed is 22,700 tests/second in compiled mode and 150 tests/second in interactive mode for 12 pins.

**DRIVER**

SHORT CIRCUIT PROTECTED

VOLTAGE RANGE -12 V to +12 V

CURRENT RANGE

HIGH -10 mA to +30 mA

LOW -30 mA to +10 mA

OFFSET VOLTAGE

OUTPUT IMPEDANCE 20 mV max

SLEW RATE 1.5 ohms typical, 3 ohms max

75 V/ $\mu$ s typical

**COMPARATOR**

VOLTAGE RANGE -12 V to +12 V

MAX VOLTAGE  $\pm 30$  V

OFFSET ERROR 25 mV max

BIAS CURRENT 200 nA typical

**PRICE:** The HP 28035A Digital Test Subsystem is available only for HP 9500-series systems. Typical systems including the digital test subsystem cost from \$50,000 up. The digital test subsystem itself costs \$6000 plus \$2500 per test module, and can be added to existing 9500-series systems.

**MANUFACTURING DIVISION:** AUTOMATIC MEASUREMENTS DIVISION  
 640 Page Mill Road  
 Palo Alto, California 94304

unless changed. Thus only changes need be transmitted to the DTU.

While only digital testing has been discussed here, 9500 systems are capable of doing both analog and digital testing, or any combination, using standard stimulus and response-measuring devices. Test programs for other types of tests are just as easy to generate as those for digital tests.

**Maintenance**

Anyone who installs a large test system is faced with a major problem if the test system fails. Down time costs money. The digital test subsystem is designed to be reliable, of course, but since a system that can never fail has yet to be devised, a diagnostic test program was developed to minimize down time should a failure occur. This program is written such that the subsystem is completely exercised and any failure within it is quickly isolated to a replaceable module or cable. With the necessary spare parts available, the time to diagnose a fault, repair it, and be back running again can typically be less than 15 minutes. Most failures can be repaired by plugging in the indicated PC board, and this can be done by relatively unskilled personnel.

**Acknowledgments**

The authors wish to acknowledge the programming efforts of Chris Beni, the analog design work of Bob Valentine and Bill Haydamack, and the mechanical design work of Larry Lim and Dick Cavallaro. Dale Ewy contributed valuable advice when we needed it. 

**Leif Gudnitz**



Leif Gudnitz came to HP in 1969 with three years of automatic test system design under his belt. He's project manager for the 28035A Digital Test Subsystem. A former Danish Air Force Sergeant, Leif is a 1964 graduate of Copenhagen Engineering College with the equivalent of a BSEE degree. He also has an MSEE degree from Rochester Institute of Technology, received in 1969. He came to the United States in 1966 after two years in nuclear instrument development in Denmark.

**Homer Tsuda**



After he received his BS degree in electrical engineering from the University of California at Berkeley in 1956, Homer Tsuda got into the systems business, developing instrumentation for digital data acquisition and a computer-controlled transistor test system. At HP since 1969, he's still in the systems business—he's the man in charge of software development for the 28035A Digital Test Subsystem. Homer's a golfer and a builder and flyer of model airplanes.

# Optical Power Measurements Made Easy

*This new low-cost radiant flux meter system gives direct radiometric measurements in the infrared, visible, and ultraviolet regions of the spectrum. It zeros and calibrates itself, too.*

**By Charles L. Hicks and Michael R. Mellon**

OPTICAL MEASUREMENT is one of the oldest and most fundamental areas of science, yet it's still one of the least mature. Optical energy is generally considered to be the portion of the electromagnetic spectrum between microwave and x-ray frequencies.\* Measurements in this region are a separate area of science because optical sources, detectors, and techniques differ markedly from those used in the microwave or x-ray regions of the spectrum. Within the optical region lie the visible wavelengths, those to which the human eye is sensitive.

The need for reliable optical measurements is greater today than ever before, and is felt in such diverse areas as laser development and applications, communication systems, air pollution studies, medicine and astronomy.

Some optical measurements can be made with a high degree of accuracy. Velocity and wavelength are two that can. On the other hand, techniques for measuring the absolute intensity of optical radiation have lagged behind corresponding methods at lower frequencies. This is partly due to the importance of the lower frequencies in radar, missile guidance, and communications, and the consequent emphasis placed on research in these areas during the last three decades. But it's also partly because of the fundamental nature of optical radiation. Everything radiates optical energy: the earth radiates to space, the human body radiates to the environment, every object in a detector's field of view radiates, and the detector itself radiates optical energy to its environment. What's more, major complications are introduced by the geometry of the optical system: factors such as the detector's field of view and the source's size, shape, and distance from the detector must be taken into account. It's easy to see that experimental technique is a critical

factor in optical measurements.

An optical researcher who builds his own power measurement system must solve numerous problems. He must first decide whether he wants the readout to be in photometric or radiometric units (see box, page 15). Next a detector must be chosen, its job being to convert optical power to a measurable voltage or current. There are quantum detectors such as photomultipliers, photodiodes, and phototransistors, and there are thermal detectors such as thermistors, thermopiles, and pyroelectric detectors. Quantum detectors are generally quite fast and have high sensitivity, but their sensitivity depends on the wavelength of the optical radiation. Thermal detectors in general are relatively slow and less sensitive but have the virtue of uniform sensitivity over wide portions of the spectrum (millions of gigahertz in some cases!).

Once the detector is chosen a voltmeter or ammeter to measure its output must be selected. It must be compatible with the detector or a special interface must be built. Finally, the researcher must figure out how to keep his system calibrated and what the worst-case error is likely to be, and then document what he has done so others can use the system.

## **A Better Way**

It's now possible to avoid these selection and interfacing problems, yet have an optical power measurement system that satisfies most requirements for speed, sensitivity, and flat spectral response, automatically zeros and calibrates itself, and is accurate within  $\pm 5\%$ . A unique new thin-film thermopile detector, used in the HP Model 8334A Detector, and a precision nanovolt-

\* See Fig. 4, page 13.

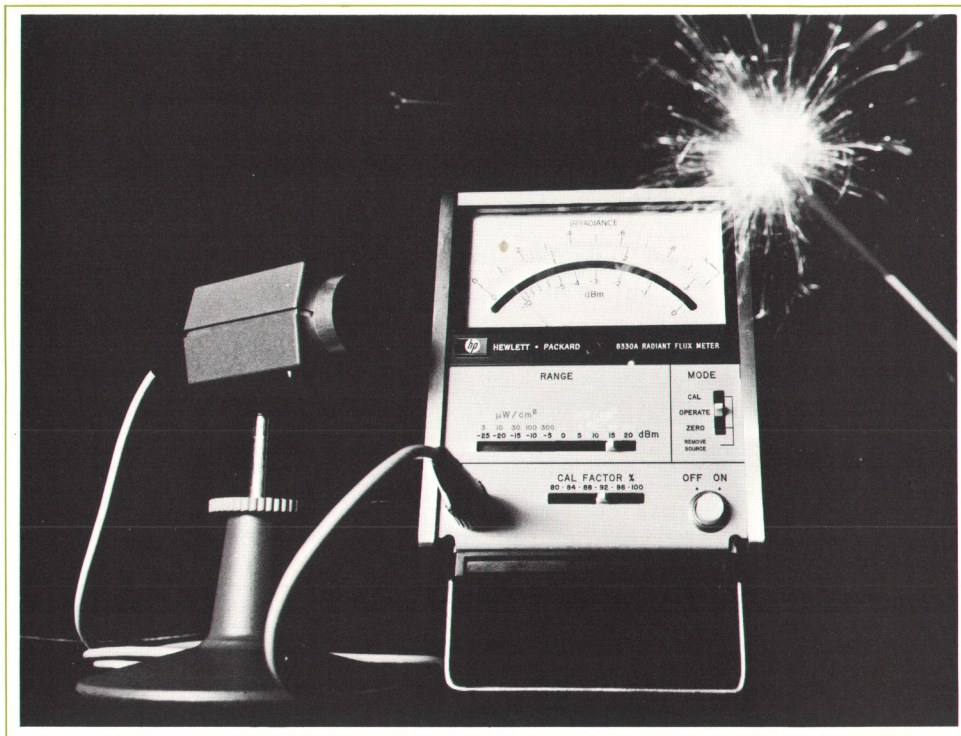

**Fig. 1.** Easy-to-use, low-cost HP 8330A/8334A Radiant Flux Meter System measures optical power in the ultraviolet, visible, and infrared regions of the electromagnetic spectrum. It reads directly in absolute radiometric units without spectral calibration curves. Maximum absolute uncertainty is less than  $\pm 5\%$  of full scale.

meter, the HP 8330A Radiant Flux Meter, give unambiguous readings of irradiance (power per unit area) from the vacuum ultraviolet region of the spectrum to the infrared.

The system (Fig. 1) has ten overlapping irradiance ranges, from  $3 \mu\text{W}/\text{cm}^2$  to  $100 \text{mW}/\text{cm}^2$  full scale, suitable for measuring power output from a wide variety of sources such as lasers, gas-discharge devices, incandescent lamps, cathode-ray tubes, light-emitting diodes, infrared sources, and blackbody radiators. No charts or calibration curves are needed because the standard system's spectral response is uniform within  $\pm 3\%$  over a wavelength range of  $0.3 \mu\text{m}$  to  $3.0 \mu\text{m}$ .<sup>\*</sup> This range can be extended to less than  $0.2 \mu\text{m}$  and more than  $15 \mu\text{m}$  using different optical window materials in the detector. With the automatic zero feature, readings can be compensated for background radiation up to  $\pm 100 \mu\text{W}/\text{cm}^2$ . This allows operation under normal laboratory light conditions. The automatic calibration feature gives the user confidence in his measurements; it assures that overall system accuracy, including meter and detector, is within  $\pm 5\%$ .

#### Fast, Broadband Thin-Film Thermopile

The key to the performance of the new optical power measurement system is the HP-developed thin-film thermopile detector. It converts optical power—ultra-

violet or infrared or anything in between—to a dc voltage directly proportional to the power. The thin-film construction minimizes the detector's thermal and inertial mass, thereby giving it fast response and high immunity to mechanical shock. It also allows small geometry, so small that 64 individual thermocouples fit in an area only 0.43 centimeter square. Fig. 2 is a photograph of the detector.

Thermopile construction begins with a sheet of aluminum foil approximately 0.004 inch thick. It's first anodized on one side and then chemically etched on the other to produce an  $8 \times 8$  array of 64 square windows—areas where the aluminum has been removed to leave only a thin (750Å) transparent layer of aluminum oxide. Next, antimony and bismuth, the thermocouple materials, are deposited on the anodized side in overlapping patterns (see Fig. 3). The patterns are such that one antimony-bismuth junction is over a window area, the next is over the thicker aluminum-foil substrate, or non-window area, the next is again over a window, and so on. The junctions over the solid non-window areas are the 'cold' or reference junctions. The aluminum-foil substrate is thick compared to the oxide, antimony, and bismuth layers, so the substrate acts as a heat sink and tends to hold the junctions over it at a uniform temperature near ambient. The junctions over the thin window areas are the 'hot' junctions. To make them hot, a black optical absorber is deposited over the window areas.

<sup>\*</sup>  $1 \mu\text{m} = 10^{-6}$  meter = 1 micron = 10,000 Å

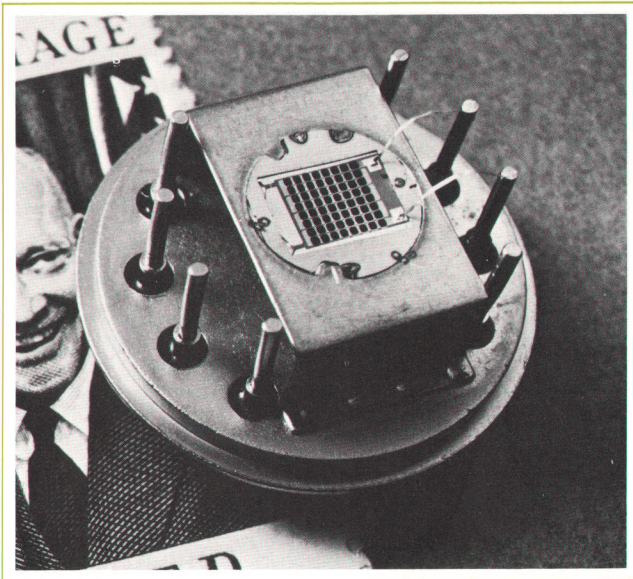

**Fig. 2.** Unique, HP-designed thin-film thermopile detector has fast five-millisecond response, low drift, and high immunity to mechanical shock.

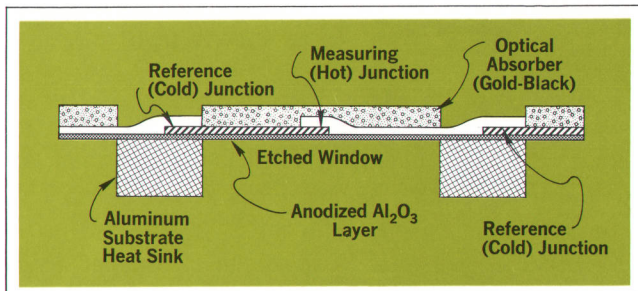

**Fig. 3.** Thin-film thermopile consists of 64 antimony-bismuth thermocouples connected in series.

Non-window areas remain reflective. Each hot-cold junction pair constitutes a thermocouple, so the complete thermopile has 64 thermocouples. All are connected in series.

When the thermopile is exposed to optical radiation the black junctions absorb energy and their temperature increases while the shiny, heat-sunk junctions reflect energy and remain near ambient temperature. This temperature difference results in a thermoelectric voltage. For antimony-bismuth couples, this voltage is about  $100 \mu\text{V}/^\circ\text{C}$ . Since the thermopile has 64 couples connected in series it has an overall sensitivity close to  $6.4 \text{ mV}/^\circ\text{C}$ .

The black optical absorber is gold-black,\* chosen primarily because of its high ratio of absorbance to mass, and because its absorbance is constant from the vacuum ultraviolet to the far infrared. Thanks to its

\* Gold-black is pure gold evaporated so that it forms an extremely rough surface, so rough that it appears black because it absorbs nearly all incoming optical radiation.

low mass, the detector responds in less than five milliseconds to a change in optical power, much faster than other thermal detectors, which often take several seconds to respond. And because of the constant absorbance of gold-black, the detector's response is limited primarily by the optical window placed in front of it. The window isn't necessary, but it reduces noise caused by air turbulence and prolongs the life of the detector by keeping out dust and chemically corrosive atmospheres. Fig. 4 shows the detector's response to different wavelengths with several types of windows.

At very long wavelengths in the infrared (greater than  $40 \mu\text{m}$ ) the thermopile's absorbing efficiency drops because some of the radiation is reflected. To minimize this effect the thermopile is mounted at the focus of a gold-plated hemispherical dome which re-reflects to the thermopile much of the energy that's reflected from it. The thermopile is sealed in the dome and the entire assembly is placed in contact with a massive aluminum block for temperature stabilization. To minimize the effects of handling and rapid ambient-temperature fluctuations, the assembly is isolated from the impact-resistant plastic case.

A field-stop aperture in the detector assembly restricts the detector's field of view to a solid angle of 0.1 steradian.\*\* This makes it easy to convert the system's irradiance readings to radiance units ( $\text{W}/\text{cm}^2/\text{sr}$ ); you just multiply by 0.1. Under appropriate conditions, readings can also be converted to radiant flux, which has units of watts. Irradiance, radiance, and radiant flux are radiometric units typically used for measuring optical power from point sources, wide-area sources, and beams, respectively (see page 15).

On the front of the detector housing is a removable bezel with 30 mm camera threads for mounting adapters to hold lenses, filters, or shutters. Behind the bezel is a  $3/4$ -in diameter cavity which holds filters at the same temperature as the thermopile to minimize self-emission in the infrared region.

### A Sensitive Nanovoltmeter

The successful application of this sensitive detector required that the input amplifier of the 8330A Radiant Flux Meter be an ultra-stable dc amplifier capable of making reliable measurements in the nanovolt range.†

The amplifier is a synchronous design (see Fig. 5) which uses a precision electromechanical chopper to convert the dc output voltage from the detector to a

\*\* 0.1 steradian is equivalent to  $10.5^\circ$  linear half-angle from the optical axis.

† 1 nanovolt =  $10^{-9}$  volt = 0.000000001 volt.

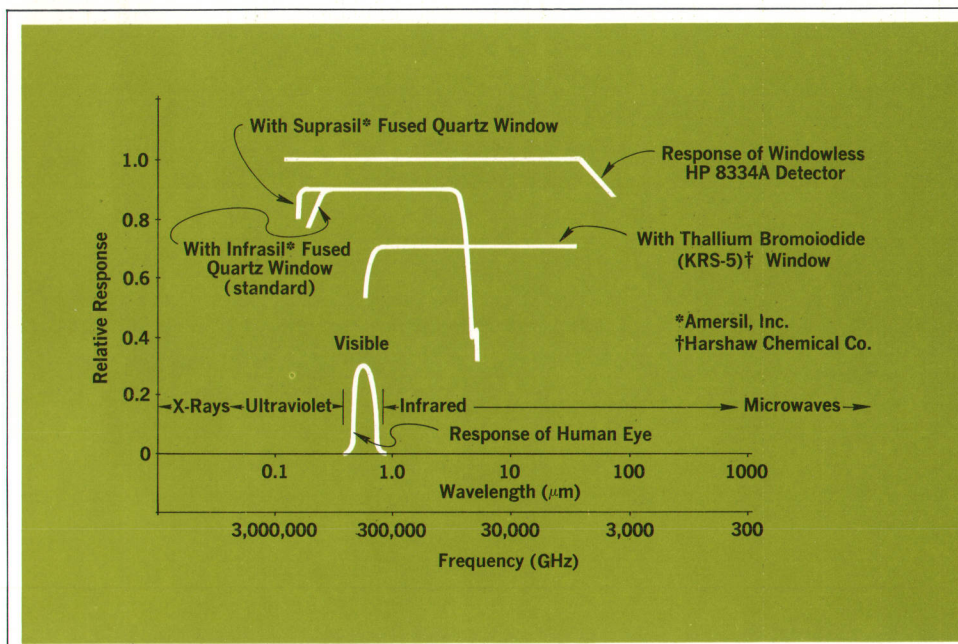

**Fig. 4.** Flat response of detector allows accurate broadband measurements. Spectral range varies with transmission characteristics of window mounted in front of thermopile.

107-Hz ac voltage with an amplitude proportional to the dc voltage. Low-level ac voltages are much easier to amplify than dc voltages, since dc drift can be eliminated in ac amplifiers.

After the dc voltage is converted to ac it's amplified by narrow-band amplifiers which reject noise and power-line-related interference. Once amplified, the voltage is converted back to dc and displayed on the meter. There's an optimum ratio between the amounts of ac and dc amplification in such a system. If there's too much ac amplification the system will tend to saturate on line-related interference. If there's too much dc amplification, drift increases. In the final design temperature-induced drift referred to the input is typically less than one nanovolt per °C and line-related interference isn't a problem. Dynamic range is approximately 100 dB.

Noise was a primary consideration in the design of the amplifier system, since it's the overall noise level that determines the smallest amount of optical power that can be measured. For this reason the first amplifier stage (after the chopper and an input transformer) is a special low-noise junction-FET amplifier. Referred to the primary of the input transformer, that is, to the point where the detector output enters the meter, the noise attributable to the entire 8330A meter is less than the thermal noise in the detector. Thus the system's sensitivity is limited more by the thermal-noise characteristics of the detector than by the amplifier.

#### Automatic Zeroing

It's convenient to be able to use an optical power

meter in normal laboratory light as well as in dark rooms. It should therefore have a zero-suppression capability so the user can compensate for background or ambient radiation and measure only the source rather than the source plus the background. Instead of the usual manually operated zero control, the 8330A has an automatic pushbutton meter-zeroing system. Pressing a single switch zeros the system with electronic speed and accuracy, and the user doesn't have to take his eyes off his experiment.

The zeroing circuit (see Fig. 5) consists essentially of a comparator amplifier and a long-term analog memory connected in a negative-feedback loop. When the front-panel MODE switch is moved to ZERO, the voltage across the meter is electronically compared to a zero-voltage reference. If there's an offset the difference voltage is amplified and channeled through a MOSFET source follower back to the input, where it nulls out the offset. The circuit will reduce any offset up to  $\pm 300$  times the lowest meter range to less than 2% of the lowest range in less than two seconds.

After zeroing, the user returns the MODE switch to its OPERATE position. This causes the output of the comparator amplifier to be disconnected from the analog memory, which is a polystyrene capacitor connected to the gate terminal of the MOSFET. The voltage that was required to zero the instrument then remains on the capacitor because the only discharge paths are via surface leakage and through the insulated gate of the MOSFET, both very high impedances. The discharge time constant

## Multitudinous Applications

Versatility and performance make the HP 8330A/8334A System useful in diverse ways in optics, process control, analytical science, and other fields. Here are some typical uses.

### Electro-optical Measurements

- radiant power from optical sources such as lasers,\* monochromators, gas-discharge devices, incandescent lamps, CRT's, LED's, infrared sources, blackbody radiators, ultraviolet sources
- analysis of optical input/output and memory devices for computers
- polarization studies (with polarizing filter)
- direct comparison of emissions at different wavelengths from continuous or discrete sources
- precision calibration of other optical detectors over broad spectral regions
- photographic and holographic exposure levels
- transmission and reflection characteristics of filters, lenses, mirrors, optical coatings, thin-films, liquids, and gases
- wideband output leveling of sources and monochromators
- determination of spectral outputs of sources (with tunable optical filter or monochromator)
- infrared research, development, and production
- educational demonstrations.

### Process Control and Analytical Science

- Remote, non-contacting temperature measurement of physical objects using infrared radiation (useful for moving, liquid, or semi-plastic objects and for inaccessible, radioactive, or corrosive environments)  
watts/cm<sup>2</sup> =  $\epsilon \sigma (T^4 - T_0^4)$ , where  
 $\epsilon$  = emissivity of surface of emitter  
 $\sigma$  = Stefan-Boltzmann constant  
=  $5.67 \times 10^{-10}$  watts/cm<sup>2</sup>/K<sup>4</sup>  
T = unknown temperature in K of emitter  
T<sub>0</sub> = temperature in K of detector (normally ambient temperature)
- infrared mapping of temperature
- rapid detection of small temperature differentials
- ambient illumination measurements
- ambient sunlight level measurements for agricultural and photochemical air pollution studies
- photobiological studies of plant growth and photosynthesis
- wideband optical detection system for optical spectroscopy, useful for ultraviolet, visible, and infrared spectroscopy at discrete wavelengths with narrowband filters
- color control and analysis (tri-stimulus)
- control of ultraviolet-activated chemical processes such as photoetching of printed circuits, microcircuits and chemical milling processes
- monitoring laser power in laser micro-machining applications.

\* Laser beams should be attenuated and/or diffused for best results.

of the analog memory is extremely long—typically several weeks. To preserve this long time constant the memory circuit is thoroughly cleaned and encapsulated in a silicone compound to keep out moisture.

### Automatic Calibration

Among the significant contributions of the 8330A/8334A system is its built-in self-calibrating feature. Instead of requiring the user to make screwdriver adjustments while measuring an external optical standard, the new system has a completely self-contained precision electronic calibrator. It's made possible by the fact that an ac voltage superimposed across the output terminals of the thermopile detector will dissipate power in the thermopile and cause a temperature rise, and this in turn will cause a thermoelectric voltage to be generated. Thus it's possible to substitute lower-frequency ac power for optical power when calibrating the system. In the 8330A a precision ac calibration voltage is derived from an electronic oscillator which operates at a frequency of 10 kHz.

Calibration is done automatically by a feedback technique similar to that used for automatic zeroing. The same front-panel MODE switch that's used for zeroing the instrument also has a CALIBRATE position. When the switch is placed in this position several things happen. First, regardless of the range setting, the instrument internally switches itself to the 3 mW/cm<sup>2</sup> range. At the same time, the precision internal electronic calibrator is connected across the thermopile detector, causing a minute temperature rise and a corresponding thermoelectric output voltage. The meter voltage is then electronically compared to 1.000 volt (full scale). If the gain of the system is properly adjusted the calibrator power will cause a detector output sufficient to give a full-scale reading on the 8330A meter. If it doesn't, the output comparator amplifier will sense a difference or error voltage. The comparator will amplify the difference and feed a correcting voltage through an analog memory circuit to the gate of a junction FET, which is used as a variable resistor in the feedback loop of one of the ac amplifiers. If the detector sensitivity is too high the correcting voltage will reduce the gain of the system to compensate for the high sensitivity. If the sensitivity is too low it will raise the gain.

This process is entirely controlled by the single front-panel switch and takes about one second. The MODE switch is then returned to the OPERATE position. This disengages the calibrator, returns the instrument to the range indicated on the front panel and disconnects the

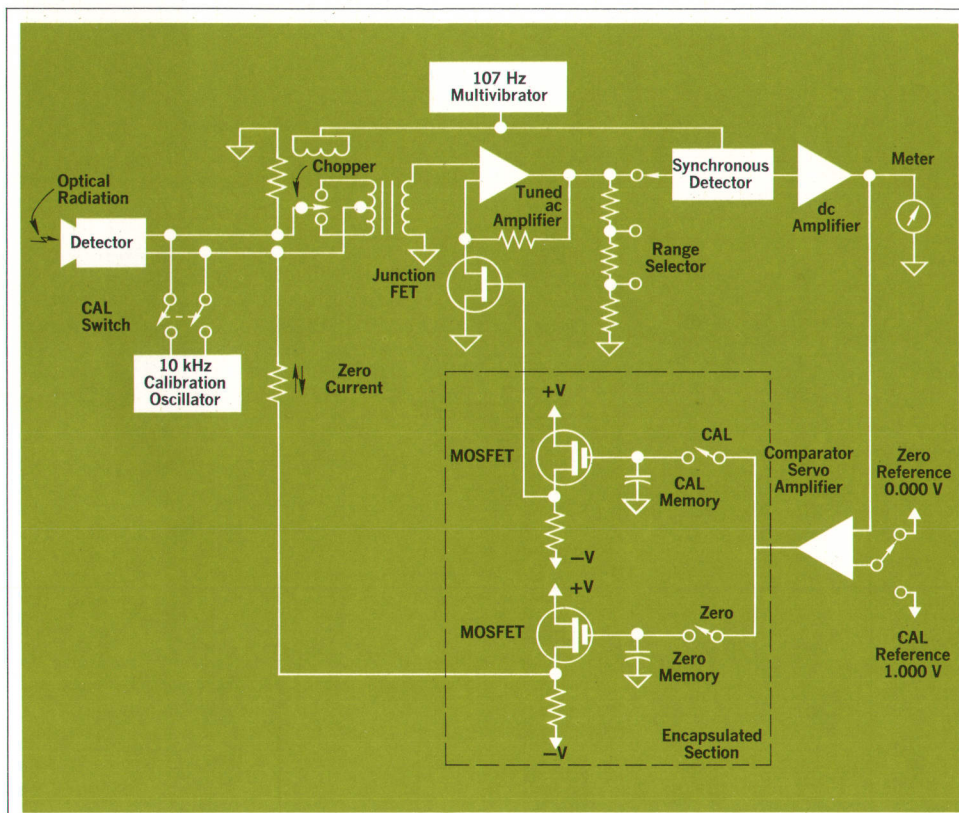

**Fig. 5.** Sensitive, low-noise input amplifier doesn't degrade detector characteristics. Automatic zero system suppresses background radiation. Automatic calibration system eliminates time-consuming calibration against external standards and increases user confidence.

comparator's output from the memory circuit. Again, however, the voltage that was required to calibrate the

system remains on the analog memory capacitor.

## Units of Optical Power

Optical instruments in common use today are designed to measure optical intensity in either of two distinct systems of units—radiometric and photometric.

Radiometric units are based on fundamental considerations of energy and power. As such, they are defined independently of wavelength and are equally applicable in the ultraviolet, visible, and infrared regions of the spectrum. The new HP 8330A/8334A Radiant Flux Meter System makes radiometric measurements.

Photometric or psychophysical units are intended only for applications related to the human eye. A photometric instrument, reading in such units as lumens, footcandles, or footlamberts, duplicates the spectral response of the 'standard' human eye (as defined by the 1931 CIE curve), which peaks sharply in the yellow-green and falls off quite rapidly in the blue and red. Photometric instruments shouldn't be used in general applications where absolute measurements are needed or where measurements made at different wavelengths—especially outside the visible—are directly compared. Serious errors can result from misuse of these instruments. For example, errors incurred in measuring the outputs of mercury arc lamps (often used in chemical processing) with a photometric instrument rather than a radiometric one might easily exceed 600%.

Frequently used radiometric units are irradiance, radiant flux, and radiance.

As a final calibration step, the user adjusts the front-panel CAL FACTOR switch to agree with the calibration factor printed on the 8334A detector. This is necessary because each thermopile has a slightly different response to 10 kHz power and optical energy. The calibration factor is measured during manufacture using standards traceable to the National Bureau of Standards and is indicated on the label of each detector.

This convenient electronic calibration scheme allows the user to calibrate his system periodically without having to maintain an optical standards laboratory. Not only does it offer him the ability to make rapid and easy calibration, it also serves as a check, giving him confidence in the system. If the meter doesn't go to full scale during the calibrating sequence the user has an obvious indication of malfunction. With conventional systems the detector's sensitivity could change drastically (and often does) and the user might not become aware of it for some time.

### Acknowledgments

Part of the basic design of the thermopile came from Hewlett-Packard Laboratories, where several people were involved, including John Brigham, Mike Ferral and Irwin Wunderman. Fred Pramann is responsible for

many of the concepts used in the 8330A including the power substitution idea. Charles Cook and Yas Matsui were responsible for the product design of the 8330A and 8334A respectively. John Hearn contributed valuable suggestions. Last but by no means least, Tony Foster did the lion's share of the work getting the system into production. 

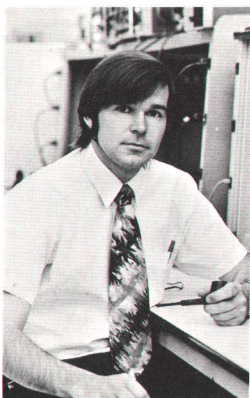

#### Charles L. Hicks

Charles Hicks is a 1966 graduate of Case Institute of Technology with a BS degree in physics. He joined HP soon after graduation and spent three years designing microwave instruments before becoming project supervisor for the 8330A/8334A system, his present responsibility. He's a member of AIP, AAS, and the Optical Society of America, and he's within sight of his MS degree in bioengineering at Stanford University.

Charles enjoys crosscountry motorcycle rides and making 8mm motion pictures. At present, however, his major leisure-time activities are related to his recently acquired one-ship navy, the 'Little Bit,' an ocean-going ketch built in 1938. He and his wife and their three cats are presently in the process of moving aboard, looking ahead to some extended cruises in tropical waters.

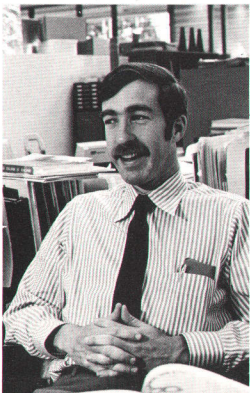

#### Michael R. Mellon

Mike Mellon came to HP in 1967, just after receiving his BS degree in electrical engineering from the University of California at Berkeley. He started out designing microwave instrumentation, but soon found marketing more to his liking. He's now product manager for the 8330A/8334A system and related instruments, responsible for marketing support and product planning.

Mike is a member of IEEE and the Optical Society of America and has done graduate work at Stanford University. Among his diversionary preferences are skiing in the Sierra Nevada and racing sailboats on San Francisco Bay.

## SPECIFICATIONS

### HP MODEL 8330A/8334A

#### Radiant Flux Meter System

#### DYNAMIC RANGE:

Radiant optical power measured in 10 full-scale ranges (1:3:10 overlapping sequence).

**IRRADIANCE:** 3, 10, 30, 100, 300 microwatts/cm<sup>2</sup>; 1, 3, 10, 30, 100 milliwatts/cm<sup>2</sup>. Readout resolution limit better than 100 nanowatts/cm<sup>2</sup>.

**RADIANT FLUX ABSORBED:** 300 nanowatts; 1, 3, 10, 30 microwatts; 0.1, 0.3, 1, 3, 10 milliwatts. Readout resolution better than 10 nanowatts.

**RADIANCE:** 300 nanowatts/cm<sup>2</sup>/steradian; 1, 3, 10, 30 microwatts/cm<sup>2</sup>/steradian; 0.1, 0.3, 1, 3, 10 milliwatts/cm<sup>2</sup>/steradian. Readout resolution better than 10 nanowatts/cm<sup>2</sup>/steradian.

Readout resolution limit defined as 3% of full scale on most sensitive range. Basic system calibration is in units of irradiance.

#### SYSTEM ACCURACY:

Maximum absolute uncertainty of broadband irradiance measurement is less than  $\pm 5\%$  of full scale on any range, including uncertainty of NBS-traceable calibration standards, transfer calibrations, linearity, and electronic instrumentation over an ambient temperature range of 0-55°C.

#### SPECTRAL RANGE AND FLATNESS:

Depends on optical window. Standard Model 8334A Radiant Flux Detector is equipped with quartz optical window and exhibits flat spectral response, typically within  $\pm 3\%$  or less, from 0.3 to 3.0 microns. Flat spectral response is extendable from less than 0.2 micron to more than 15 microns using other optical window materials.

#### SYSTEM RESPONSE TIME 10-90%:

Measured at Recorder/Digital Voltmeter output:  
 < 70 milliseconds on 3, 10, 30, 100 mW/cm<sup>2</sup> ranges,  
 < 0.7 second on 100, 300  $\mu$ W/cm<sup>2</sup> and 1 mW/cm<sup>2</sup> ranges,  
 < 2.7 seconds on 3, 10, 30  $\mu$ W/cm<sup>2</sup> ranges.

#### EFFECTIVE CLEAR FIELD-OF-VIEW:

0.1 steradian solid angle. Clear angle 3.5° linear half-angle. Complete cutoff occurs at 18° half-angle.

#### AMBIENT TEMPERATURE OPERATING RANGE:

0-55°C.

#### AUTOMATIC METER ZERO:

Pushbutton control provides automatic zeroing of meter on any range. Enables zero suppression of up to 100  $\mu$ W/cm<sup>2</sup>.

#### AUTOMATIC CALIBRATOR:

Pushbutton control operates electronic substitution-type calibrator that maintains accuracy of system regardless of changes in sensitivity of detector or use of different detectors.

#### CALIBRATION FACTOR CONTROL:

Normalizes amplifier gain to correspond to Calibration Factor of particular Model 8334A Radiant Flux Detector in use. Can also be used to compensate meter reading for known transmission losses of filters, located in the optical path. 2% steps from 60% to 100% in 2 ranges (range switch located on rear panel).

#### RECORDER/DIGITAL VOLTMETER OUTPUT:

Supplies analog voltage proportional to meter deflection, with 1.00 volt corresponding to full scale. BNC connector on rear panel.

#### FILTER COMPARTMENT:

Holds 3/4-in diameter round filters at detector cavity temperature to provide narrow bandpass and yet eliminate self-emission from filters.

**PRICE: Model 8334A, \$450.00**  
**Model 8330A, \$650.00**

**MANUFACTURING DIVISION: SCIENTIFIC INSTRUMENTS GROUP**  
 1601 California Avenue  
 Palo Alto, California 94304

## HEWLETT-PACKARD JOURNAL JULY 1971 Volume 22 • Number 11

FROM THE LABORATORIES OF HEWLETT-PACKARD COMPANY 1501 PAGE MILL ROAD, PALO ALTO, CALIFORNIA 94304 U.S.A.  
 Hewlett-Packard S.A. 1217 Meyrin - Geneva, Switzerland • Yokogawa-Hewlett-Packard Ltd., Shibuya-Ku, Tokyo 151 Japan

Editor: R. H. Snyder Editorial Board: R. P. Dolan, H. L. Roberts, L. D. Shergalis Art Director: Arvid A. Danielson Assistant: Maridel Jordan